

حل كتاب تدريبات

Workbook

الصف السادس

الفصل الدراسي الثاني

1) Match the definitions with the appropriate pictures:

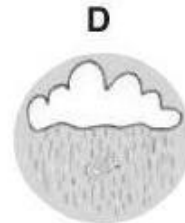
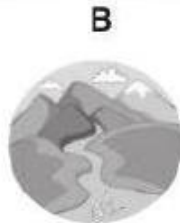
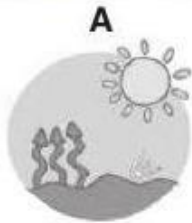

- 1- It happens when much water in the clouds falls back to earth.
- 2- Water vapour changes into clouds.
- 3- Water turns into vapour.
- 4- When water collects back into lakes, rivers or seas.

A	B	C	D
3	4	2	1

2. Complete the following diagram with information about the water cycle:

Use the sentences in the diagram and the following linkers (First, Then, Next, Finally) to write a paragraph in your notebook:

Topic sentence

Water goes on a long cycle until we can drink it...

Supporting Detail 1

Water turns into vapour.

Supporting Detail 3

Water vapour changes into clouds.

Supporting Detail 3

Water in clouds fall back to earth.

Supporting Detail 4

Water collects back into lakes, rivers or seas.

Concluding Sentence

We have to thank Allah for giving us fresh water by preserving this water and not wasting it.

Unit 7

3. Use the words and pictures to write sentences in the passive following the example:

1- Goals/ score/ football

Goals are scored in football.

2- Zebras / keep/ zoo

Zebras are kept in the zoo.

3- A doctor / see / hospital

A doctor is seen at the hospital.

4- Books/ read/ library

Books are read in the library.

5- Old coins and pots/ find/ museum

Old coins and pots are found in the museum.

6- Fruits/ and vegetables/ buy/ market

Fruits and vegetables are bought at the market.

7- Stars/ see/ sky

Stars are seen in the sky.

4. Complete the sentences using the passive:

Money **is kept at the bank.**

food **is kept in the fridge.**

Books **are kept on the shelf.**



Remember

In active sentences

(Thing doing action) + (verb) + (thing receiving action)

example: **Huda cleans the dishes.**

In passive sentences, the thing receiving the action is the subject of the sentence and the thing doing the action is optionally included near the end of the sentence.

(Thing receiving action) + (be) + (past participle of verb) + (by) + (thing doing action)

example: **The dishes are washed by Huda.**

5.  Listen and say the words.

shapes noses pictures

6.  Write each word in the correct place. Listen. Are you right?

eyes noses ducks ears lines pictures
cups exercises shapes dishes minutes

-s sound	-iz sound	-z sound
shapes ducks cups minutes	noses dishes exercises	pictures ears lines eyes

7. Name these shapes.

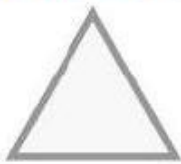

t **triangle**



c **circle**

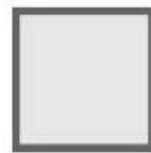

s **square**

8. Look and draw a fun picture.

Look at picture D on page (62) of your Student's Book. Use one of these shapes to make your own fun picture.

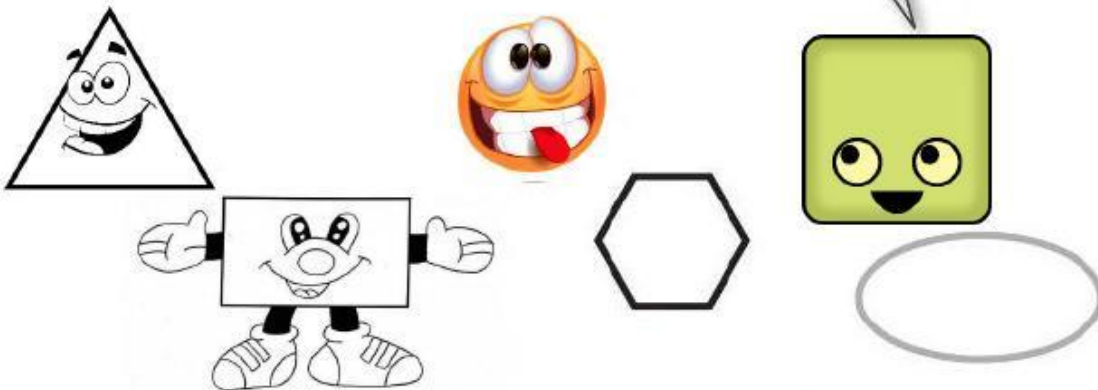

عبد النعم صابر

Unit 7

9. Read, do and make.

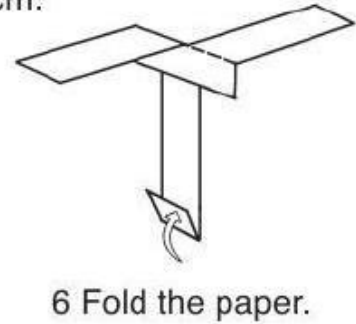
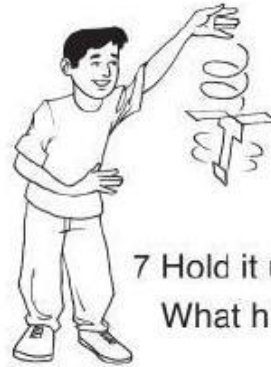
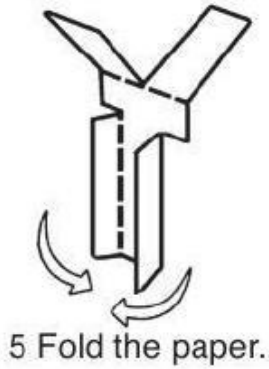
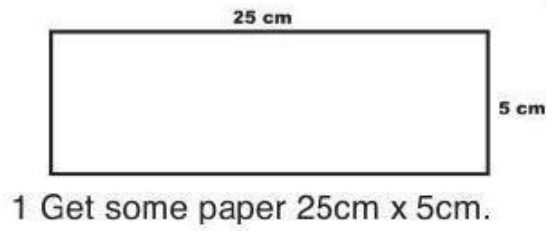
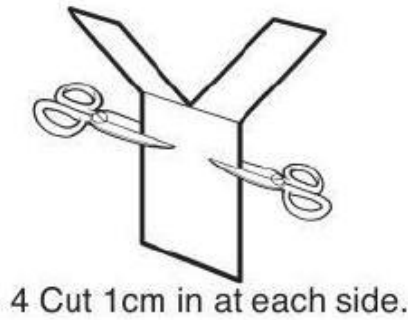
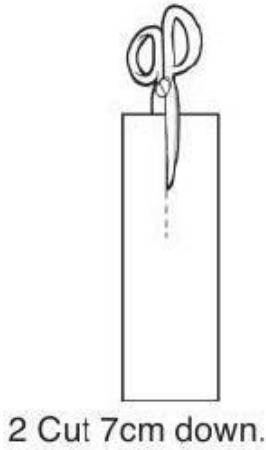

10. Complete the table:

First	Get some paper 25cm X 5cm.....
Second	Cut 7cm down.....
Third	Fold the paper.....
Fourth	Cut 1cm in at each side.....

11. What did you need to do the experiment?

I needed:

1. A piece of paper
2. A pen
3. Some colours
4. Scissors
5. A dish with some water

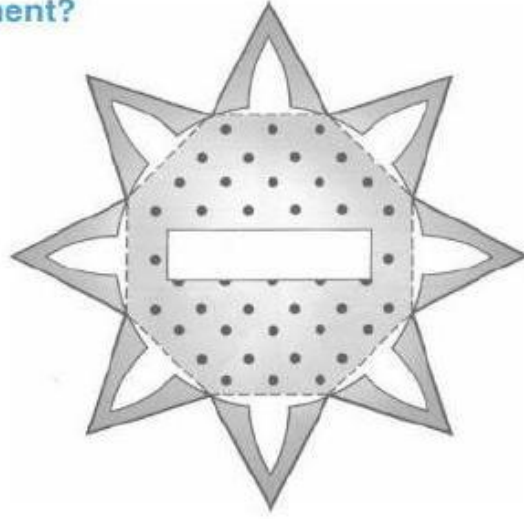

12. Write about the experiment. How is it done?

First, the picture is copied on some paper. Then, my name is written in the middle. After that, the picture is coloured and cut out. The triangles are folded into the middle. Some water is put in a dish. Finally, the picture is put on the water.

13. What happened? Choose the correct word.

The shape opened / closed.

14. Why do you think it happened?

When the picture is put on the water, it gets wet and becomes heavier so it opens like a flower.

عبد النعم صابر

Science in our Life

1. Look at page 10 of your Student's Book. Correct these false sentences.

1. Many rich countries do not have safe drinking water.
Many poor countries do not have safe drinking water.
2. It is very cheap to make clean water in Kuwait.
It is very expensive to make clean water in Kuwait.
3. A poor old man has invented the LifeStraw.
Some scientists have invented the LifeStraw.
5. You can only use the LifeStraw to drink from lakes.
You can use the LifeStraw to drink any water.
4. The LifeStraw is made of wood.
The LifeStraw is made of plastic.

2. Write sentences about the pictures.



A knife is used for cutting bread, meat, etc.



A box is used for keeping things.



A camera is used for taking photos.



Goggles are used for diving.



A racket is used for playing tennis.



A diary is used for writing notes.

Remember

To be used + for + Verb + ing

A pen is used for writing

عبد النعم صابر

3. Talk to your friends about next weekend. Complete the table. Write sentences.

Name	will	won't	might
Me	visit grandma	go shopping	watch TV
Walaa	go shopping	watch TV	read a book
Sara	go to the beach	go shopping	swim

Have you got any plans for this weekend, Nura?



Well, I might go shopping. I won't watch any TV but I will play tennis.



First, the picture is copied

Nura might go shopping. She won't watch any TV but she will play tennis.

ME: I might watch TV. I won't go shopping but I will visit grandma.

Walaa might read a book. She won't watch TV but she will

Friend 1 go shopping.

Sara might swim. She won't go shopping but she will go to

Friend 2 the beach.

4. Work with a friend. What jobs could these pupils do when they leave school?

Name: Nadia **Teacher**
 Good at: Arabic, English
 Likes: looking after children

Name: Bader **Footballer**
 Good at: football
 Likes: football

Name: Maha **Doctor**
 Good at: Maths and Science
 Likes: helping people

Name: Sami **Pilot**
 Good at: Geography, English
 Likes: planes

Remember

Use will to talk about the things that will happen for sure.

Use won't to talk about things that are not going to happen.

Use might and could to talk about the things that may or may not happen.

Unit 8

عبد النعم صابر

5. Complete the crossword.

Across →

2 The LifeStraw is made of _____.

4 The opposite of cheap.

5 Very, very small living things.

You can't see them – some are dangerous.

7 You can drink through this.

8 This can be sunny, hot, cold, rainy, etc.

Down ↓

1 A person who studies or teaches science.

3 A very large piece of ice that you can see in the sea.

6 Electricity, etc. makes this.

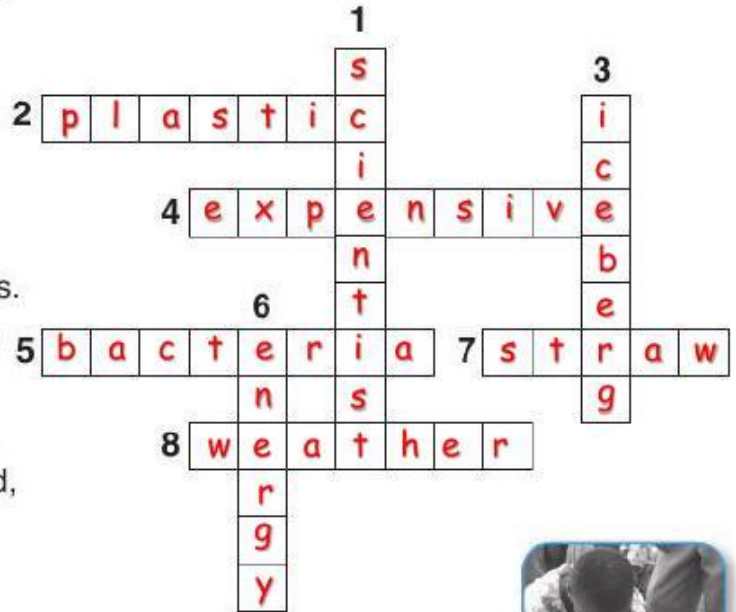

6. The underlined letters all have the same sound. Listen and repeat.

flood

country

dust

colour

young

funny

done

enough

brush

glove



Say these sentences.

1. Dan has brushed the dust away.
2. Have you got a hat and some gloves?
3. We have never had a flood in our country.
4. That's a funny colour!



7. Questionnaire: Are you saving energy?

	Yes	No
1- Are all your light bulbs energy-saving?		
2- Do you remember to turn lights off?	✓	
3- Do you keep the air conditioner down?		✓
4- Do you switch appliances off?	✓	
5- Do you fix dripping taps and showers?	✓	
6- Do you leave tap on when you brush your teeth?	✓	
7- Do you walk to school?		✓
8- Do you have more than one car?	✓	
9- Do you see solar energy?		✓

8. Compare your answers with your friend's. Who is more interested in saving energy?

9. How can you save energy? Use the ideas in the previous task to write a paragraph about saving energy.

Your paragraph should have a sentence and supporting details.

Saving energy is very important because we need it in our
everyday life. We can save energy by many ways. We can turn
off the lights when we aren't using them. We can turn off
the air conditioners when we go out. We should use solar
energy. We can walk to school if we live near it. We can also
use one car only to save energy.

9. Ahmed went on the visit to Failaka Island. Read his report.

Our class visit to Failaka

Last week my class went to Failaka Island to visit the museum and look at the old buildings. (1) **b**

First we got a bus from our school to the harbour. Then we got a boat to Failaka Island. (2) **d**

When we arrived, we went to the museum. (3) **f** It was very interesting.

Then it was lunch time. We sat down together and ate. (4) **e** We talked to each other about the island while we were eating.

After lunch, we walked round the old buildings on the island. Suddenly, Faisal called out and we all went to see what he had. He was holding a beautiful earring. (5) **c** Just then, a tourist came up to him.

It was her earring. (6) **a**

Finally, we went home - very tired but very happy.

10. Ahmed's report needs more information. Put a to e in the correct places.

- a) Faisal was very sad it wasn't very old but the tourist was really happy.
- b) Our teacher told us a lot about it so we were very excited.
- c) He asked the teacher if it was very old. He wanted to take it to the museum.
- d) The sea was not rough and the sunshine was warm. It was a lovely day.
- e) We all brought different food to eat and it was delicious.
- f) A man told us about old coins, pots and bottles which they sometimes find there.

11. Write your own report about a visit.

~~Last weekend, I went to the zoo with my family. We went by car. The weather was nice and the sun was shining. We took sandwiches and the food was delicious. We saw many animals and birds. The monkey was funny. It likes bananas and fruit. We came back home very happy.~~

1 Choose the right word to finish each sentence.

- 1 Al-Khawarizmi was born in about (780/1978).
- 2 He lived in (Kuwait/Baghdad).
- 3 He was born in (Baghdad/Khawarizm).
- 4 He was an (author/artist).
- 5 He was best known for (stamp collecting/
algebra).
- 6 He was very interested in (geography/history).
- 7 He made the first map of (Baghdad/the world).



2 Answer these questions about you.

1 When were you born?

I was born in 2007.

2 Where were you born?

I was born in Kuwait.

3 Where is your home now?

My home is in Salmeya.

4 Where was your grandpa's home when he was a child?

It was in Kuwait City.

5 What are you interested in?

I'm interested in reading and playing football.

3 Now ask and answer the questions from Exercise 2 with a friend.

عبد النعم صابر

4. Change books with a friend. Use question tags to make sure the information from Exercise 2 is correct.

You were born in Kuwait City, weren't you?

5. Listen to the past tense of these verbs. Write them in the correct place.

- | | | | | | |
|------|--------|-------|-------|-------|------|
| ask | want | play | like | climb | open |
| look | arrive | point | brush | land | need |

/ d /	/ t /	/ id /
played	asked	wanted
opened	liked	pointed
arrived	looked	landed
climbed	brushed	needed

6. Write questions and answers with the words.

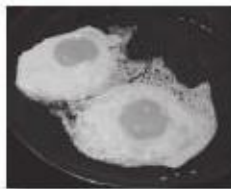

- go to Failaka Island last weekend
Did you go to Failaka Island last weekend?
No, I didn't. I went to the zoo.
- eat eggs for breakfast this morning
Did you eat eggs for breakfast this morning?
No, I didn't. I ate cheese.
- do Maths homework yesterday
Did you do Maths homework yesterday?
No, I didn't. I did English homework.
- read a book about Al-Khawarizmi last week
Did you read a book about Al-Khawarizmi last week?
No, I didn't. I read a book about Kuwait.

Remember

Question tags are short questions at the end of statements.
 - A **positive statement** is followed by a **negative question tag**.
 Jack is from Spain, isn't he?
 - A **negative statement** is followed by a **positive question tag**.
 They aren't funny, are they?
Don't forget to use the proper pronoun instead of the noun

عبد النعم صابر

7. Write the words.

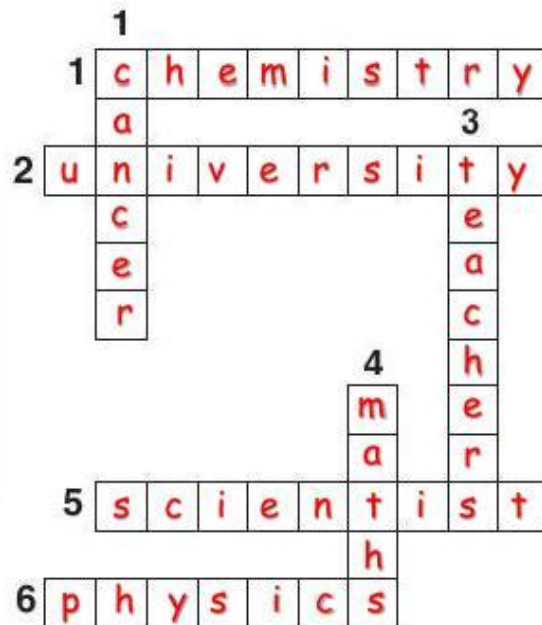
**Across** →

1. Marie Curie won her second important prize in _____.
2. You go here to study when you have left school.
5. Marie Curie was this.
6. Marie and Pierre Curie won an important prize for this in 1903.

Down ↓

1. The Curies worked to find a cure for this.
- 3 Marie Curie's parents were both _____.
- 4 You study algebra in _____.

8. Choose the correct answers. Write the letters in the boxes.

When you write the letters, you will find the name of Marie Curie's child. She also won an important prize.

- 1 Marie Curie (is born [S]/was born [I]) in 1867.
- 2 Her parents (were [R]/was [U]) both teachers.
- 3 Marie (works [S]/worked [E]) hard at school.
- 4 Marie (studied [N]/studies [A]) Physics and Maths.
- 5 She (meets [N]/met [E]) Pierre Curie in 1894.

I	R	E	N	E
---	---	---	---	---

11. Think of inventions that start with the following letters:

C: Car

P: plane

R: Radio

T: Television

10. Which invention is according to you the most important? Surf the net to find out information to complete the following spider-gram:

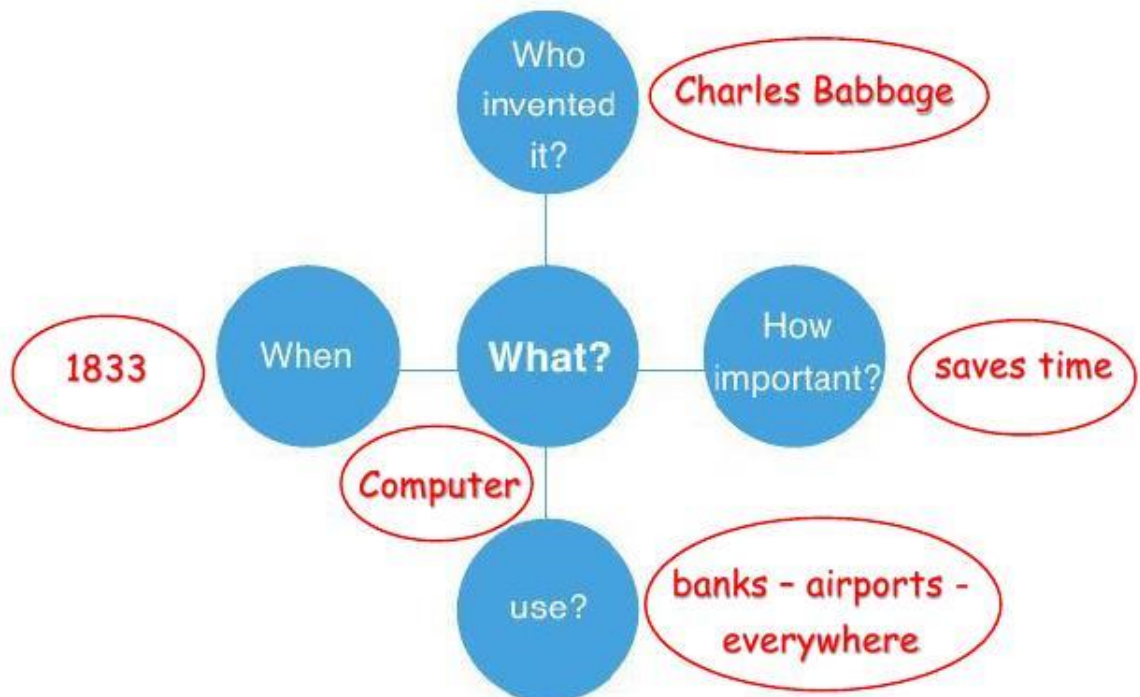

11. Develop your notes into a well-structured paragraph.

Remember

- the topic sentences.
- the supporting details.
- punctuation marks.

Write the topic in your note book.

A biography

12. Choose a person to write about.

The person can be famous, or someone you know.

13. Write questions about the person.

Use the question words and add two more questions.

Who? Sheikh Jaber Al-Ahmed

What? Thirteenth Emir of Kuwait

Where? Kuwait

When? 29 June, 1926

How many? 79 years

Why? He served Kuwait and its people all his life. He created the Future Generations Fund and the Marter Office.

14. Write about the person. Answer all the questions you have written.

Sheikh Jaber Al-Ahmed Al-Subah is the thirteenth Emir of Kuwait. He was born in Kuwait on 29th June, 1926. He died at the age of 79. He served Kuwait and its people all his life. He created the Future Generations Fund and the Marter Office.

15. Read to your friend. Can he/she guess who you wrote about?

عبد النعم صابر

Progress Check

عبد النعم صابر

Read the following text to answer the question below:

Pure water is a clear, colourless, odourless and tasteless liquid. All living creatures need water in order to survive. Forty to ninety percent of the weight of all living organisms is water. The human body needs water to get rid of wastes and to transport nutrients throughout the body.

Ancient Scientists thought of water as a basic part by which all other liquids are measured. At the end of the eighteenth century, a British chemist made water by using a mixture of hydrogen and oxygen. We now know that water consists of two parts hydrogen, the most abundant element in our world, and one part oxygen, the element that we breathe in order to survive.

Choose the right answer:

- 1- The main idea of the text is the importance of
 - a) the human body
 - b) hydrogen
 - c) oxygen
 - d) water
- 2- The word "abundant" in line 8 means:
 - a) present in small areas
 - b) present in different shapes
 - c) present in great quantity
 - d) present in small amount.
- 3- The opposite of the word "survive" in line 2 means
 - a) use
 - b) measure
 - c) die
 - d) breathe

4. Which of the following is true?

- a) Water smells like apples.
- b) Water smells like orange juice.
- c) All living things need water in order to survive.
- d) None of these

5. What percentage of your body weight is water?

- a) 30%
- b) 10%
- c) 70%
- d) 95%

II. Language.

A/ Do as shown between brackets:

1. we send the e-mails in the morning. (Make passive)

The e-mails are sent in the morning.

2. I drink one bottle of water daily.

3. Adel is from Kuwait, isn't he? (Complete with a tag question)
4. He isn't from Britain, is he? (Complete with a tag question)
5. Tomorrow is Friday. we (~~will~~ won't) go to school. (Choose the correct answer)

عبد النعم صابر

Unit 9

B. Crossword

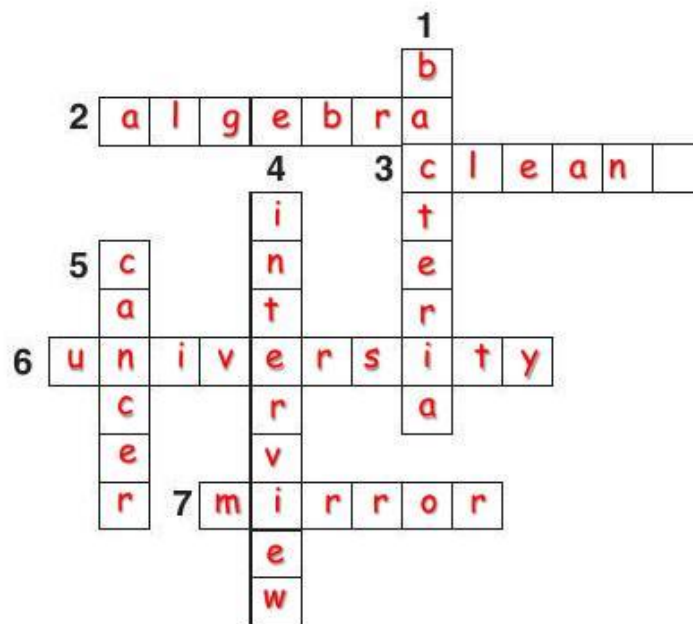

Across →

2. maths which uses letters and signs.
3. not dirty
6. a place where students can go to study after leaving school
7. a thing in which you can see yourself

Down ↓

1. very small living things which can make people ill
4. when one person asks another person questions
5. a very bad illness

عبد النعم صابر

1. Tick the things you need for each sport.

	ball	bat	racket	net	goggles	football boot
1. football	✓					✓
2. table tennis	✓	✓		✓		
3. tennis	✓		✓	✓		
4. swimming					✓	

1. You need a ball and football boots for football.
2. **You need a ball, a bat and a net for table tennis.**
3. **You need a ball, a racket and a net for tennis.**
4. **You need goggles for swimming.**

2. Read the letter and number the fish.

Hi Mona,

I love scuba diving. Last week we saw three fish. Here is a picture of them. The first one had very big eyes but it wasn't very big. It looked beautiful. The second one was very fat with small eyes. It looked funny. The third one was long like a snake. It looked sad.

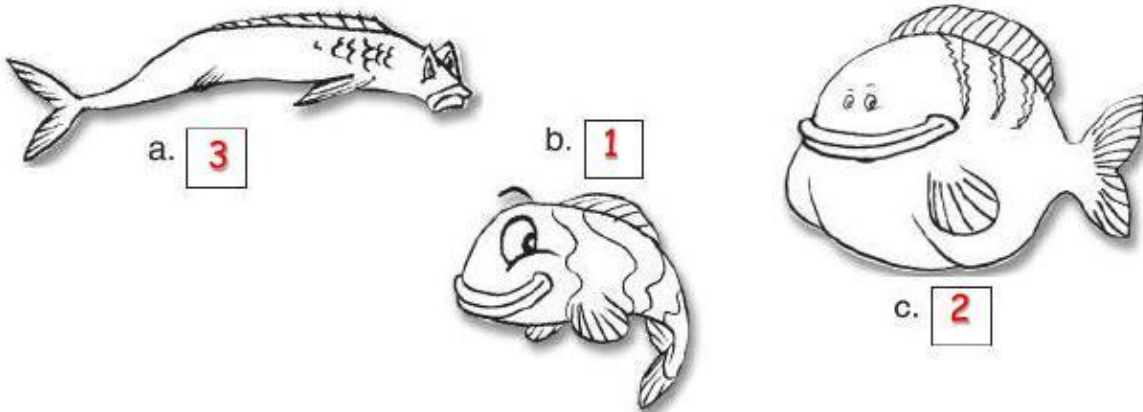

Unit 10

3. Finish the sentences with the correct form of the verbs.

1. I am going to write to my grandmother this evening. (write)
2. My friend wrote a very good story last week. (write)
3. We are going to visit Failaka Island next weekend. (visit)
4. We visited Dickson House in our last holiday. (visit)
5. My mother is going to buy me some new shoes tomorrow. (buy)
6. My brother bought a computer last weekend. (buy)

4 Write the sports words.

		2		3		4					
1	t	a	b	l	e	t	e	n	n	i	s
		a		e		w					
		s		n		i					
5	s	k	i	i	n	g	m				
		e		i		m					
		t		s		i					
		b				n					
		a		6	d	i	v	i	n	g	
		l									
		l									







Across →

1. You need a bat, a ball, a table and a net for this sport.
5. You need snow for this sport.
6. You go under the water in this sport.

Down ↓

2. Tall people can play this sport.
3. You need a racket, a ball and a net for this sport.
4. You get wet when you do this sport.

Remember

We use to be + going to + verb (inf.) when:

1. We want to talk about a planned action for the future.

I am going to visit you on Wednesday.

2. We are making a prediction.

It is really cold. I am sure it is going to snow tomorrow.

عبد النعم صابر

5.  Listen and say.

swimming playing writing going

6.  Listen and tick (✓) the correct sentences.1. **a** I swim in the sea.

b I'm swimming in the sea.

2. **a** I write stories in my book.

b I'm writing stories in my book.

3. **a** We play in a team.

b We're playing in a team.

4. **a** We're going to have a picnic.

b We go and have a picnic.

7. Finish the sentences with a sport.

1. I like **playing football** _____.2. I don't like **skiing** _____.3. My friend's good at **swimming** _____.4. I'm not good at **playing basketball** _____.**Remember**(like / good at) are followed by
verb + ing

It's quiz time!

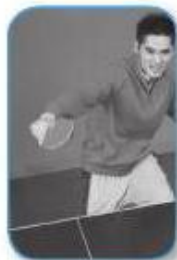
8.  Listen and guess the sport.1. **Tennis** _____2. **Football** _____3. **Basketball** _____4. **Swimming** _____

9. Finish the table about your upcoming visit to a country.

The country I'm going to visit	Who I'm going to go with and how long I'm going to stay	What I'm going to do and see there
London	My father. 10 days.	Shopping. Visiting museums.

10. Use the information in the table to write to a friend.

Remember

1. Use the correct beginning.
2. Think about your first sentence; the reason for writing.
- 3/4. Organize your ideas; one paragraph for each main idea.
5. End the e-mail.

This message has not been sent

Send

To: myfriend@hotmail.com

Cc:

Subject: My visit to London

1 Dear Hamad.....

2 Thanks for your last e-mail. You said you are going to spend the next holiday in
Kuwait. You wanted to know where I'm going to spend the next holiday.....

3 I'd like to tell you that I'm going to spend the next holiday in London. I'm going
to travel with my father only because he has some work there.....

4 We are going to stay in London for 10 days. I'm going to go shopping at Oxford
Street. I'm going to visit the museums there also.....

5 Write soon,
Omar.....

Writing an E-mail

11. Write notes about yourself.

Name: OmarHow old you are: 11Number of brothers: 2Number of sisters: 1Father's job: PolicemanMother's job: TeacherPet: ParrotPet's name: PollySchool big or small: bigNumber of pupils: 880Favourite school lesson: EnglishSports you play: Football

12. Write to your new friend.

Use the notes you have written. Write a first e-mail to your new friend.

Dear Mark

I'm very happy to write my first e-mail to you so I'm going to tell you about myself.

My name is Omar. I'm 11 years old. I have two brothers and one sister. My father is a policeman and my mother is a teacher. I have a parrot at home, It's name is Polly.

My school is big and it has about 880 pupils. My favourite school lesson is English and my favourite sport is football.

Write soon,

Omar

13. Type the e-mail using your smart device and send it to your friend.

عبد النعم صابر

A Beautiful Country

1. Work in pairs. Match the pictures and the sentences.

Come to New Zealand – an exciting country

1. There are lots of sea animals and birds. You can go out in a boat and watch the animals swimming in the sea. **b**



2. Mount Cook is a very high mountain. Some people like to climb it but it is very difficult. Walk around the National Park instead – it's easier! It's very beautiful. **a**

3. Do you want to see what is in the sea around New Zealand? Try scuba diving off the east of North Island. You can see some beautiful fish. **d**



4. Finally, from June to October there is a lot of snow, so you can go skiing. Some of the best skiing is on the mountains on South Island. **c**

2. Make sentences.

Example:

Oman is bigger than UAE.
 UAE is bigger than Kuwait.
 Oman is the biggest.

big → bigger → biggest



- The rabbit is faster than the cat.
 The cat is **is faster than the mouse**.....
 The rabbit **is the fastest**.....
- Nasser is older than Nora**.....
Nora is older than Khaled.....
Nasser is the oldest.....
- The elephant heavier than the cow**.....
The cow is heavier than the giraffe.....
The elephant is the heaviest.....

fast → faster → fastest

Animal	Speed (mph)
rabbit	35
cat	30
mouse	8

old → older → oldest

Name	Age
Nasser	12
Nora	10
Khaled	8

heavy → heavier → heaviest

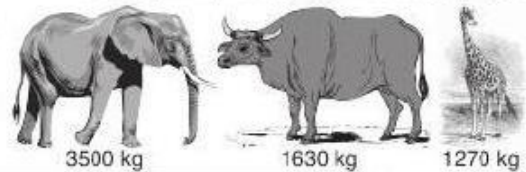

Remember

Short adjectives ending in vowel + consonant, remember to double the final consonant before -er/ -est. **big → bigger → biggest**

If the adjectives ends in -e, just add -r or -st. **wise → wiser → wisest**

With adjectives ending in y, you change the y to i and add er/ est.

happy → happier → happiest

3. Complete the table





Short adjectives	-er	-est
hot	hotter	hottest
lucky	luckier	luckiest
large	larger	largest

4.  Listen and write the number of syllables in each word.

Hospital has **three syllables**:
hos – pit – al

- | | | | |
|---------------|--|----------------|--|
| 1. airport | <input style="border: 1px solid red; width: 20px; height: 20px;" type="text" value="2"/> | 2. beach | <input style="border: 1px solid red; width: 20px; height: 20px;" type="text" value="1"/> |
| 3. city | <input style="border: 1px solid red; width: 20px; height: 20px;" type="text" value="2"/> | 4. volcano | <input style="border: 1px solid red; width: 20px; height: 20px;" type="text" value="3"/> |
| 5. population | <input style="border: 1px solid red; width: 20px; height: 20px;" type="text" value="4"/> | 6. island | <input style="border: 1px solid red; width: 20px; height: 20px;" type="text" value="2"/> |
| 7. beautiful | <input style="border: 1px solid red; width: 20px; height: 20px;" type="text" value="3"/> | 8. interesting | <input style="border: 1px solid red; width: 20px; height: 20px;" type="text" value="4"/> |

5. Match the signs and the directions.

- | | | | |
|--|--|---|--|
| a.  | b.  | c.  | d.  |
| 1. turn right | <input style="border: 1px solid red; width: 20px; height: 20px;" type="text" value="b"/> | 2. turn left | <input style="border: 1px solid red; width: 20px; height: 20px;" type="text" value="a"/> |
| 3. go past the hospital | <input style="border: 1px solid red; width: 20px; height: 20px;" type="text" value="d"/> | 4. go straight on | <input style="border: 1px solid red; width: 20px; height: 20px;" type="text" value="c"/> |

6. Start at the school. Read and then draw Ahmed's house on the map.

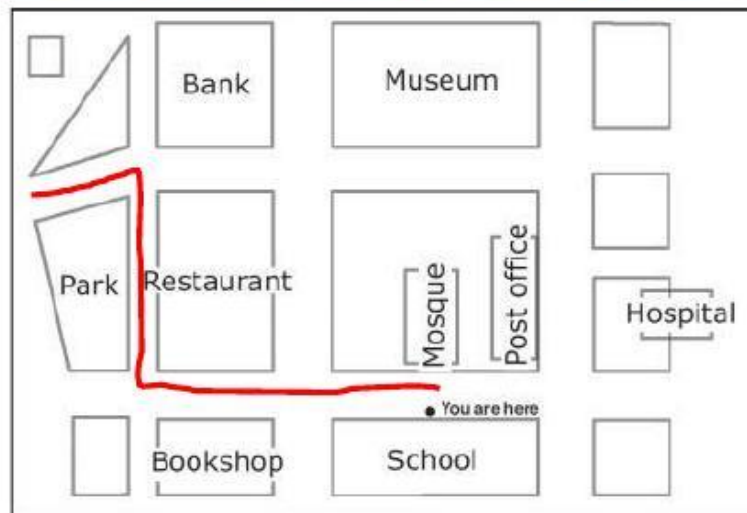

Go out of the school and turn left. Walk straight on. Go past the bookshop on your left and the restaurant on your right. Take the next right. Go past the park and turn left. Ahmed's house is on the right.

Writing a Description of a Place

7. Use the words in the box to name the places in the picture.

sea mountain lake river
beach island forest house

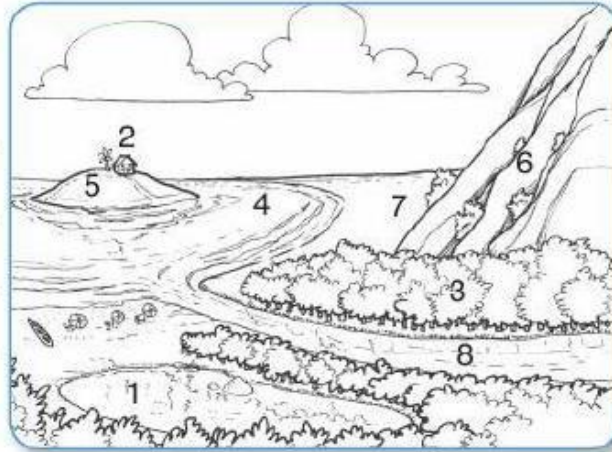

- 1.lake.....
- 3.forest.....
- 5.island.....
- 7.beach.....

- 2.house.....
- 4.sea.....
- 6.mountain.....
- 8.river.....

8. Write the words.

Find the name of a country near New Zealand.

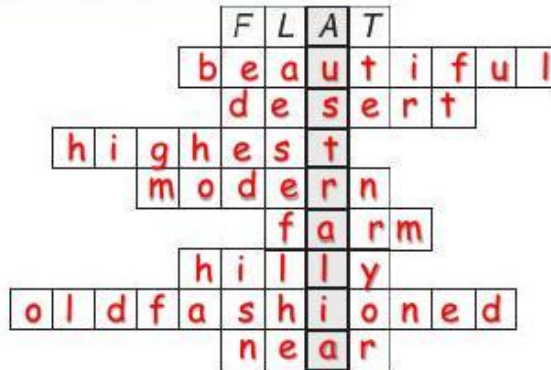

- 1 Kuwait hasn't got any mountains – it is beach
- 2 Go scuba diving and you can see beautiful fish.
- 3 The Sahara is the biggest desert in the world.
- 4 Mount Cook is the highest peak in New Zealand.
- 5 Hospitals in Kuwait are not old – they are new and modern
- 6 People grow things on a farm
- 7 Not flat = hilly
- 8 Kuwait is not old-fashioned – it is very modern.
- 9 Do you live near the school or far away?

9. Work in pairs. Look at the picture. Tick the words you can use to describe the picture.

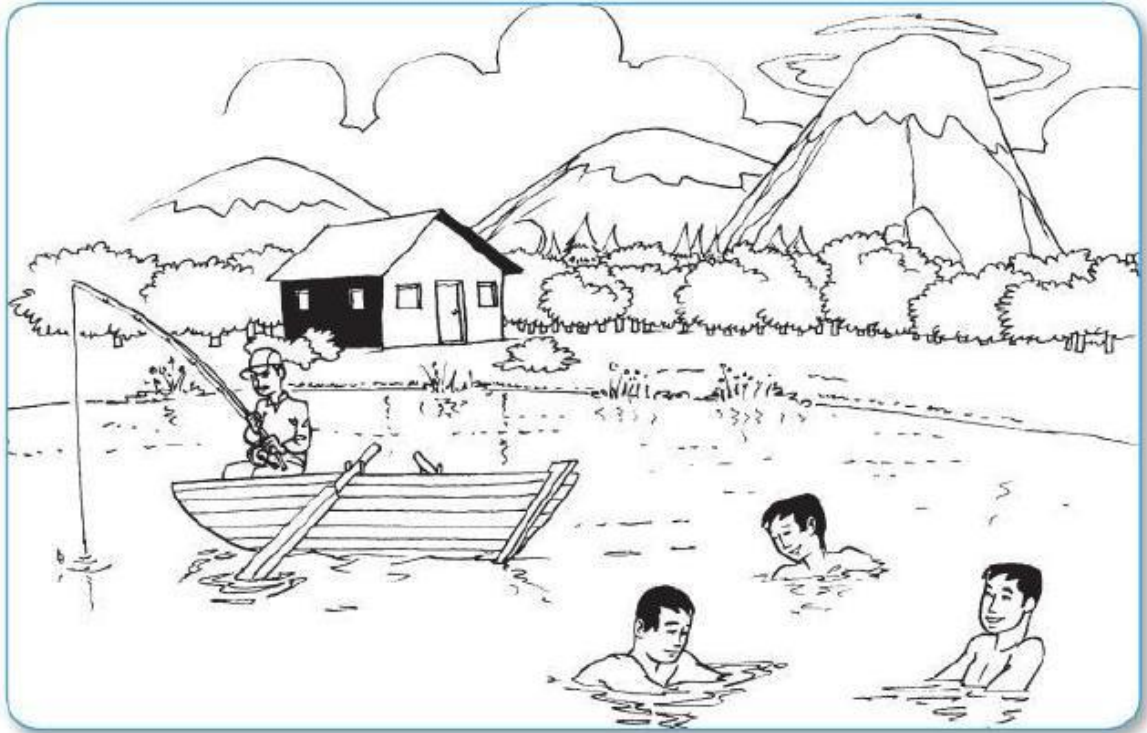

- | | | | | | | | | | | | |
|-----------|-------------------------------------|---------|-------------------------------------|--------|-------------------------------------|----------------|--------------------------|-------------|-------------------------------------|---------|--------------------------|
| beautiful | <input checked="" type="checkbox"/> | beach | <input checked="" type="checkbox"/> | shells | <input type="checkbox"/> | island | <input type="checkbox"/> | mountain | <input checked="" type="checkbox"/> | rainy | <input type="checkbox"/> |
| snow | <input type="checkbox"/> | river | <input checked="" type="checkbox"/> | lake | <input checked="" type="checkbox"/> | sea | <input type="checkbox"/> | fishing | <input checked="" type="checkbox"/> | walking | <input type="checkbox"/> |
| swimming | <input checked="" type="checkbox"/> | running | <input type="checkbox"/> | forest | <input checked="" type="checkbox"/> | large building | <input type="checkbox"/> | small house | <input checked="" type="checkbox"/> | | |

10. Write a description of the picture.

I can see a beautiful place. There is a small house. There are high mountains at the background. There is a large forest with many trees. There is a man fishing in a boat. There are some boys swimming. The weather is nice. Everyone is happy.

Unit 12

On Holiday

1. The date today is Wednesday 16th June. Write the dates.



1. What date is it the day after tomorrow? Friday 18th June.
2. What date is it tomorrow? Thursday 17th June.
3. What date was it the day before yesterday? Monday 14th June.
4. What date will it be in a fortnight? Wednesday 30th June.
5. What date was it yesterday? Tuesday 15th June.

2. Think of the words. Do not use the same word twice.

1. Name two water sports. Swimming - diving
2. Name two sports you play with a ball. Football - basketball
3. Name a sport you play with a racket. Tennis
4. Name two sports you do outside. Climbing - skiing

3.  Saif is on holiday. What is he going to do? Listen and tick (✓).

	golf	scuba diving	tennis	volleyball
Sunday			✓	
Monday				✓
Tuesday			✓	
Wednesday		✓		
Thursday	✓			

عيد النعم صابر

Unit 12

4. Look at the picture and tick (✓).

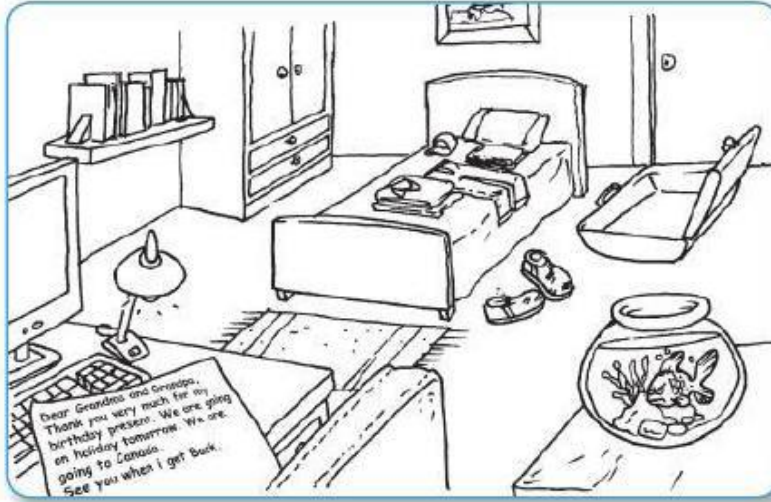

Bader is going on holiday tomorrow. His mother wrote down the things he must do. Has he done them?

Remember

Yet / already are used with the present perfect tense. *Yet* is used to talk about something that did not happen till this moment. *Already* is used to indicate that something has happened earlier.

	<i>not yet</i>	<i>already</i>
<i>clean your shoes</i>	✓	
<i>put your clothes in your bag</i>		✓
<i>put your books on the shelf</i>		✓
<i>write to Grandma and Grandpa</i>		✓
<i>give food to your fish</i>	✓	
<i>turn your computer off</i>		✓

5. Now write sentences.

Bader hasn't cleaned his shoes yet.

- Bader has already put his clothes in his bag.**
- Bader has already put his books on the shelf.**
- Bader has already written to Grandma and Grandpa.**
- Bader hasn't given food to his fish yet.**
- Bader has already turned his computer off.**

6. Match the holiday photos and the people.

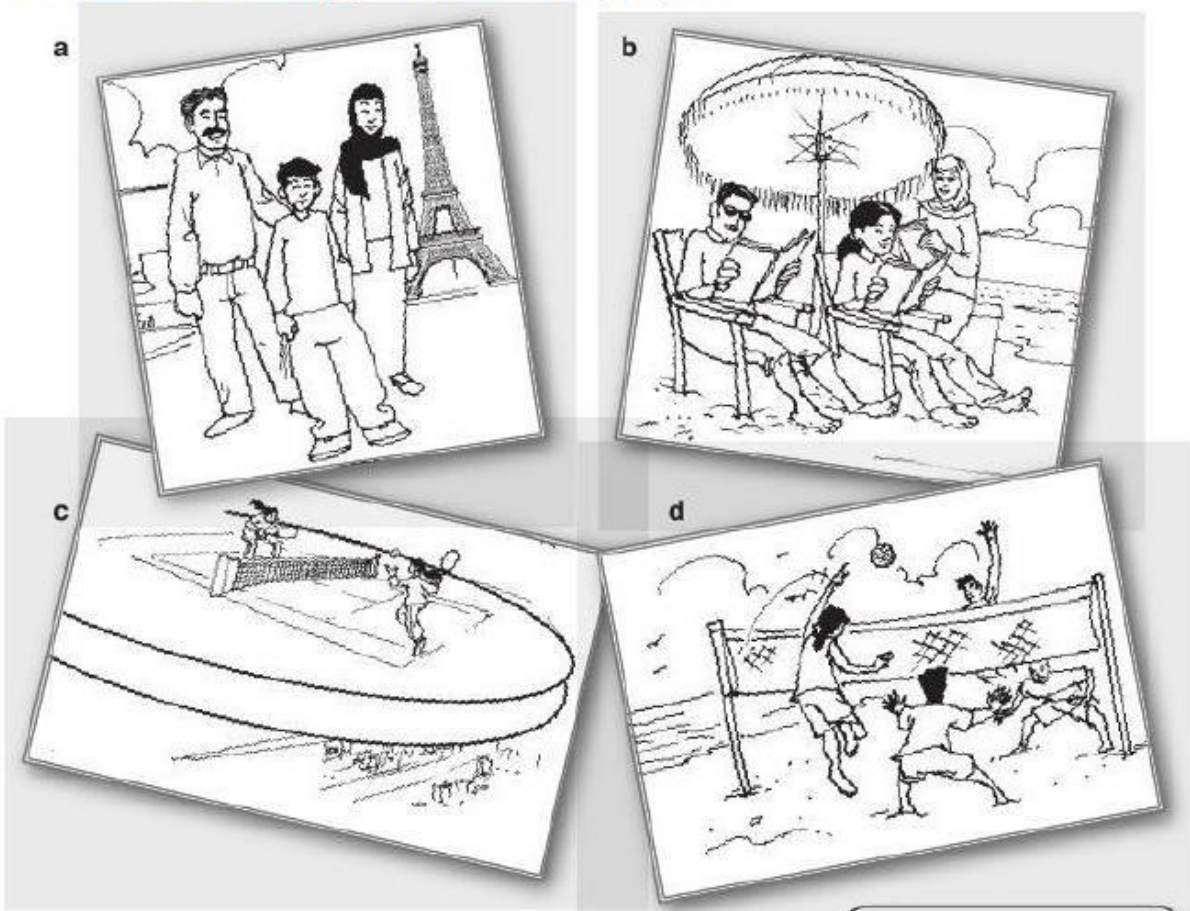

We had a great holiday. We went to the beach everyday. We played volleyball and went in the sea.

d



We had a wonderful holiday. We walked up a tall tower. The view was great.

a



We had the best holiday. The weather was beautiful. We went to the beach but we didn't play we sat and read our books.

b



We had a great holiday. We stayed in a wonderful hotel and played tennis on the roof! The view was beautiful!

c

7. Tell the members of your group what you did on your last holiday.

8. Join the beginnings and the endings. Make correct sentences.

- | | |
|---------------------------|------------------------------------|
| 1. d we arrived | a) by plane |
| 2. a We came | b) some wonderful museums |
| 3. e We're staying | c) in some interesting restaurants |
| 4. b I've visited | d) on Saturday |
| 5. c I've eaten | e) at a very old-fashioned hotel. |

9. Complete the checklist below. Share your choices with your group.

Things I want to do on holiday

- | | |
|--|---|
| <input checked="" type="checkbox"/> Take photographs | <input type="checkbox"/> play tennis |
| <input type="checkbox"/> Scuba diving | <input checked="" type="checkbox"/> read stories |
| <input checked="" type="checkbox"/> Eat ice-cream | <input type="checkbox"/> Do yoga |
| <input type="checkbox"/> Go fishing | <input checked="" type="checkbox"/> Ride a horse |
| <input type="checkbox"/> Visit interesting places | <input checked="" type="checkbox"/> Go camping |
| <input checked="" type="checkbox"/> Go shopping | <input checked="" type="checkbox"/> Visit museums |

10. You are on holiday. Write an e-card to your best friend. Use these questions as a guide:

- Where are you?
 What is the weather like?
 What is the food like?
 Where are you staying?
 What interesting places are there to visit?

Hi Omar,

We're on holiday in Cairo. The weather is fine and sunny. The food is delicious. We're staying at a modern hotel by the Nile. There are many interesting places to visit here like Old Cairo, The Pyramids and The National Museum.



11. Design and type the e-card using your smart devices and send it to your friend.

Writing an E-Card

12. Think of a place for a holiday. Find information about it. Write it here.

Where do you want to go?	I want to go to Turkey.
What's the weather like?	The weather is fine.
How can you get there?	I can go there by plane.
What can you see there?	I can see museums and mosques.
What can you do there?	I can go shopping.

13. You are on holiday. Finish this e-card.

Dear Sara _____

I am having a wonderful holiday here in Turkey _____.

The weather is fine but cold at night. _____

Yesterday we went shopping to buy some presents. _____

It was interesting. _____

Tomorrow we are going to Istanbul to visit the old mosques there and enjoy eating delicious food. _____

See you soon.

Dema _____

عبد النعم صابر

Progress Check

Reading

Canada is the second largest country in the world. It is in the northern part of North America. It is near the USA and Greenland. It is also next to the Pacific, Arctic, and Atlantic Ocean. It has the longest coastline in the world. Toronto is the biggest city but Ottawa is the capital.

A large number of people from almost every part of the world come to live in Canada. Around 35 million people now live in it. English and French are widely spoken in Canada. The Canadian people are friendly, polite and helpful. They are also famous for respecting laws and rules.

Canada welcomes millions of tourists every year. There are plenty of attractions to see like the Niagara Waterfalls, Lake Louise, and the CN Tower. Tourists can do a lot of activities, too. In the summer, they can go swimming, camping and cycling. During the winter, they can enjoy skiing, skating and playing hockey.

1. Complete the following graphic organizer with information from the text.

Location In the northern part of North America.		People Around 30 million people. Friendly and polite.
Attraction to see The Niagara Waterfalls, Lake Louise and the CN Tower.		Activities to do Swimming and camping in summer. Skiing and skating in winter.

2. Answer the following questions.

1. What does the underlined word "plenty of" in the 3rd paragraph mean?
It means "a lot of"
2. What does the underlined pronoun "they" in the 3rd paragraph refer to?
It refers to tourists.
3. Would you advise your friends to visit Canada? Why? Why not?
Yes, I would because it is a beautiful country.

3. Complete the e-mail below with words from the box.

lake / family / tennis / math / mountains / scuba diving / swimming / forest

Dear Ahmed,How are you? I'm fine. My**family**..... all say "Hi"Last weekend we visited my aunt and uncle. They live near some **mountains**There is also a**lake**..... in front of their house. My cousins and I went.....**swimming**..... in it. It was great fun. Behind their house is a**forest**....

I don't think any dangerous animals live there!

Tomorrow I'm going to play**tennis**..... after school and at theweekend I'm going to go ...**swimming**.... This evening I have to do my.....**math**..... homework.

Write soon, Ahmed

Best wishes,

Peter

Grammar

4. Complete these sentences with "yet" or already".

1. Have you visited a different country**yet**.....?
2. I have**already**..... read an English book this month. Have you?
3. I haven't tried to play golf**yet**..... Have you?
4. I have**already**..... stayed in three different hotels. Have you?

5. Put the adjectives in the following sentences in the correct form.

1. The Nile is the (long)**longest**..... river in the world.
2. Which is (big)**bigger**....., Qatar or Saudi Arabia?
3. The blue whale is the (heavy)**heaviest**..... animal in the world.
4. Eating fruit and vegetables is (healthy)**healthier**..... than eating fast food.

عبد النعم صابر